

Landlord Insurance

Product Disclosure Statement



Contents

Introduction

| | |
|---|----|
| Welcome to Suncorp Landlord Insurance | 3 |
| Summary of insured events | 5 |
| Summary of important claims information | 7 |
| About your sum insured | 8 |
| About your premium | 8 |
| Paying your premium | 9 |
| Your responsibilities | 10 |
| When you need to contact us | 11 |

About your cover

| | |
|---|----|
| Who we cover – You/Your | 12 |
| Where we cover – the insured address | 12 |
| What we cover as your property | 12 |
| What we do not cover as your property | 13 |
| The most we will pay for property claims | 13 |
| What we cover as your contents | 14 |
| What we do not cover as your contents | 15 |
| The most we will pay for contents claims | 16 |
| GST | 16 |
| What you are covered for – Insured events | 17 |
| Additional features | 25 |
| Additional covers | 29 |
| Optional covers | 33 |
| Legal Liability | 36 |
| General exclusions | 38 |

Claims

| | |
|----------------------------|----|
| Making a claim | 43 |
| How to establish your loss | 45 |
| Your excess | 46 |
| How we settle your claim | 47 |
| Property claims | 48 |
| Contents claims | 53 |
| Other claims information | 54 |

Other Important Information

| | |
|------------------------------------|----|
| What happens with cancellations | 55 |
| Cancellation fee | 55 |
| Words with special meanings | 56 |
| How we will deal with a complaint | 60 |
| General Insurance Code of Practice | 61 |
| Report insurance fraud | 61 |
| Financial Claims Scheme | 61 |

Introduction

Welcome to Suncorp Landlord Insurance

Why is this document important?

This Product Disclosure Statement (PDS) is an important legal document that contains details of your Suncorp Landlord Insurance if you purchase this product from us. Before you decide to buy this product from us, please read this PDS carefully. If you purchase this product, your policy comprises of this PDS and your certificate of insurance which shows the details particular to you.

The information in this PDS was current at the date of preparation. We may update some of the information in the PDS that is not materially adverse from time to time without needing to notify you. You can obtain a copy of any updated information by visiting www.suncorp.com.au or by contacting us on **13 11 55**. We will give you a free paper copy of any updates if you request them.

In some circumstances the terms and conditions of this PDS may be amended by a Supplementary PDS (SPDS).

PED Guide

Throughout this PDS you will be referred to a guide called: Premiums, Excesses, Discounts and Claim Payments Guide, indicated as 'Refer to the PED Guide for further information'. This guide will provide you with further information and is available at www.suncorp.com.au/moredetails. You can also obtain a copy of this guide on request, at no charge, if you contact us.

Cooling off period

After this insurance begins or you renew your policy for another period of insurance, you have **21** days to consider the information in your PDS. This is called the 'cooling off period'. If you wish, and provided you have not made a claim, you can cancel your insurance within **21** days from the day cover began or was renewed. We will then refund in full any money you have paid.

Who is this product designed for?

This product is designed to provide insurance cover for owners of investment properties that are tenanted. You may also choose to cover the contents in your tenanted property or unit.

This product does not provide cover to any portion of your unit which is legally part of a strata title building.

Your duty of disclosure

You have a duty of disclosure to tell us everything you know, or could reasonably be expected to know, is relevant to our decision to insure anyone under the policy, including you, and on what terms.

It includes matters we specifically ask about when you apply for a policy, or renew or alter your policy, and any other matters which might affect whether we insure you and on what terms.

The information you tell us can affect:

- the amount of your premium;
- if we will insure you;
- if special conditions will apply to your policy.

You do not need to tell us of anything which:

- reduces the chances of you making a claim; **or**
- we should know about because of the business we are in; **or**
- we tell you we do not want to know.

If you are unsure it is better to tell us. If you do not tell us something which you know or should know is relevant, we might reduce a claim, refuse to pay a claim, cancel your policy or, if fraud is involved we can treat the policy as if it never existed.

Exclusion for new policies

We do not insure you for bushfire, storm, flood or tsunami in the first **72** hours of your policy. Very limited exceptions apply. For full details see 'General exclusions' on pages 38 to 42.

More than one named insured

If there is more than one named insured on your certificate of insurance, we will treat a statement, act, omission, claim, request or direction (including to alter or cancel your policy) made by one as a statement, act, omission, claim, request or direction by all those named as insured on your certificate of insurance.

Some words in your policy have special meanings

Some words when used in this PDS have special meanings. Most of the words with special meanings are defined in the 'Words with special meanings' section on pages 56 to 59.

Summary of insured events

This summary lists the insured events that we cover with an example of what we do not cover in relation to that insured event. This is a summary only and there are other things we do not cover. For full details of what we cover and do not cover you for, read your certificate of insurance and the full PDS carefully, including pages 17 to 24, and in the 'General exclusions' on pages 38 to 42 of this PDS.

| | |
|---|---|
| <p>Flood</p> <p>But we do not cover loss or damage to retaining walls, sea walls, garden borders and free standing outdoor walls.</p> <p>More details page 17</p> | <p>Storm</p> <p>But we do not cover the cost of cleaning mud or clearing debris out of tanks, swimming pools or spas, including replacing or storing the water.</p> <p>More details page 18</p> |
| <p>Lightning</p> <p>But we do not cover loss or damage caused by power failures or surges by your power provider.</p> <p>More details page 18</p> | <p>Fire</p> <p>But we do not cover loss or damage to your property or contents from arcing, scorching or cigarette burns unless a fire spreads from the initial burn spot.</p> <p>More details page 19</p> |
| <p>Earthquake</p> <p>But we do not cover loss or damage that occurs more than 72 hours after the earthquake.</p> <p>More details page 19</p> | <p>Tsunami</p> <p>But we do not cover loss or damage that occurs more than 72 hours after the tsunami.</p> <p>More details page 19</p> |
| <p>Theft or burglary by tenants and their guests</p> <p>But we do not cover loss or damage when we have accepted a previous claim under this insured event in the same period of insurance in respect of the same tenant.</p> <p>More details page 19</p> | <p>Theft or burglary by people who are not tenants or their guests</p> <p>But we do not cover loss or damage caused by you or your tenants or their guests.</p> <p>More details page 19</p> |
| <p>Accidental breakage of glass</p> <p>But we do not cover any costs if the breakage does not extend through the entire thickness of the damaged item (e.g. chips or scratches).</p> <p>More details page 20</p> | <p>Escape of liquid</p> <p>But we do not cover wear and tear, or loss or damage caused by the escape of liquid occurring as a result of a gradual process of bursting, leaking, splashing, dripping or overflowing over a period of time when you could reasonably be expected to be aware of this condition.</p> <p>More details page 21</p> |

Impact

But we do not cover the cost of removing or lopping fallen trees or branches that have not damaged the property or contents.

More details page 22

Explosion

But we do not cover the cost of repairing or replacing the tank or container that exploded.

More details page 23

Malicious acts or vandalism by tenants or their guests

But we do not cover loss or damage when we have accepted a previous claim under this insured event in the same period of insurance in respect of the same tenant.

More details page 23

Damage by an animal

But we do not cover loss or damage caused by insects, vermin or rodents (some limited exceptions apply).

More details page 22

Riot, civil commotion or public disturbances

More details page 23

Malicious acts or vandalism by people who are not tenants or their guests

But we do not cover loss or damage caused by you or your tenants or their guests.

More details page 24

Summary of important claims information

This summary lists some of the important information to consider when making a claim. This is a summary only and there are other things you should be aware of when making a claim. For more details see pages 43 to 54.

Making a claim

It is important that you contact us as soon as possible after the loss or damage has occurred. You must also take reasonable steps to prevent further loss or damage.

More details page 43

Establishing your loss

You will need to prove that an incident covered by your policy has occurred and also the extent of the loss or damage you have suffered.

More details page 45

Proof of ownership

We may ask for proof of ownership in the event of a claim.

More details page 45

Excess

An excess is the amount you ordinarily have to pay for each incident when you make a claim. The excess(es) that apply depend upon the circumstances of the claim.

More details page 46

How claims are settled

Depending on the circumstances we will decide to repair, replace, rebuild or pay you what it would cost us to repair, replace or rebuild.

Some items, for example paintings, cannot be replaced and we explain how we will settle claims for such items in this PDS.

More details page 47

About your sum insured

What is a sum insured?

The sum insured is the most you can claim for any one incident unless stated otherwise in this PDS. The amount is shown on the certificate of insurance or in this PDS and includes GST.

Make sure your sum insured is adequate

Underinsurance can expose you to serious financial loss if a claim occurs. It is your responsibility to make sure your property and contents are insured for their full 'new for old' replacement value.

To help you calculate the replacement value of your property and contents, we provide a 'Building Calculator' and a 'Contents Calculator' that you can access at our website, www.suncorp.com.au.

Review your sum insured regularly

You need to ensure your sums insured are accurate when you first insure your property and contents and each time you renew your policy. To ensure your sums insured are adequate it is important to review them regularly, being mindful of items purchased recently, and ask us to change the sum insured when required.

If you over-insure

We will not pay more than it costs us to rebuild, repair or replace your property or contents.

We will not refund any premium paid for over-insuring.

Adjustments on renewal

We automatically adjust the property sum insured and contents sum insured on your certificate of insurance at the end of each period of insurance to account for various factors including inflationary trends.

About your premium

The premium is the amount you pay us for this insurance and it includes stamp duty, GST, other government charges and any fire services levy (FSL) that applies. The total amount payable will be shown on your certificate of insurance or, if you pay by instalments, the amount due each month will also be shown on your certificate of insurance as 'monthly instalment'.

In addition to your sum insured, we use many factors about you and your property and contents to work out your premium. These are called premium factors. The premium factors we use reflect the likelihood of you making a claim together with other factors related to our cost of doing business.

Each time you renew your insurance your premium is likely to change, even if your personal circumstances have not changed. This is because premiums are affected by other things such as our expenses of doing business and changes in our approach to how we calculate your premium.

Your premium includes any discounts we have given you.

[Refer to the PED Guide for further information](#)

Paying your premium

We will tell you how much you have to pay and how much time you have for payment on your certificate of insurance. You must pay the premium by the due date to get this insurance cover. You can pay in one annual payment or, if we agree, by instalments. If you pay your premium by instalments it costs you more than if you choose to pay your premium in one annual payment.

Unless we tell you, any payment reminder we send you does not change the expiry or due date. If you do not pay the full amount, we may reduce the period of insurance so it is in line with the amount you paid.

If you make a change to your policy details it may affect your premium you need to pay for the remainder of your period of insurance.

Late annual payments

If you do not pay your premium by the due date in the first year of insurance with us, we will give you a written notice of policy cancellation where we are required by law to do so.

If you do not pay the premium due on renewal by the due date, you will have no cover from the due date.

If we accept your late payment, we might recommence your cover from the date we receive your payment. If so, you will have no cover for the period from the due date until the date of payment.

Overdue instalments

If you pay your premium by instalments and your instalment is overdue, we can do one or both of the following:

- refuse to pay a claim if an instalment is **14** days (or more) overdue;
- cancel your policy without notifying you in advance if an instalment is **1** month (or more) overdue.

Your responsibilities

You must:

- keep your property or unit and any contents well maintained and in good condition. For what we mean by 'good condition' see 'Words with special meanings' on pages 56 to 59;
- take all reasonable care to prevent theft, loss, damage or legal liability;
- follow all the terms and responsibilities set out in your policy;
- provide honest and complete information for any claim, statement or document supplied to us;
- ensure that your property complies with local government or other statutory requirements at all times.

Not meeting your responsibilities

If you do not meet your responsibilities, it may lead us to do one or both of the following:

- reduce or refuse to pay your claim;
- cancel your insurance policy.

When your property or unit will be unoccupied for more than 60 days

We will apply the unoccupied excess to each incident covered by your policy unless this policy states that no excess applies to your claim if, at the time of the incident, the property or unit has been unoccupied for more than **60** continuous days.

A period of unoccupancy starts when the property or unit becomes unoccupied and comes to an end when you, or someone nominated by you, has occupied the property or unit for at least **2** consecutive nights. You may be asked to prove the occupancy of the property or unit in the event of a claim. This may be supported by the usage of the utilities that are connected to the property or unit. Sometimes we might ask for other evidence of occupancy. We will decide if the unoccupied excess applies.

If you have to pay an unoccupied excess it is payable in addition to any other excess that applies to your claim. For more details about the unoccupied excess, see page 46.

When you need to contact us

You must contact us when:

- you or your agent become aware your tenant starts to operate or intends to operate a business activity at the insured address;
- you or your agent become aware of changes to any business activity operated at the insured address, such as:
 - the type of business activity changes;
 - people start to come to the insured address;
 - business signage is installed;
 - storage of chemicals for the business activity occurs;
- any detail on your certificate of insurance is no longer accurate, such as the insured address;
- you intend to demolish your property, have lodged an application to do this, or a government authority has issued a demolition order;
- the insured address ceases to be tenanted;
- trespassers (squatters) occupy the insured address;
- you commence building or renovations at the insured address;
- anything else happens that increases the chance that loss, damage or injury will occur at the insured address;
- you no longer have a rental agreement (see ‘Words with special meanings’) for the insured address.

What we will do when you contact us

When you contact us and tell us about these changes, we may decide to impose an additional excess, charge an additional premium or apply a special condition to your policy. In some cases, it could mean we can no longer insure you and we will cancel your policy.

About your cover

Who we cover – You/Your

You/Your refers to the person or persons named as the insured on your certificate of insurance.

If the insured shown on your certificate of insurance is a company, trustee of a trust or body corporate, then you/your refers to:

- that company, trustee or body corporate; **and**
- any company director, company owner or trust beneficiary of that company, trustee or body corporate.

Where we cover – the insured address

We cover your property and contents at the insured address. The insured address is the address/location shown on your certificate of insurance. It also includes all land adjoining the insured address that you have a legal right to occupy, if the land adjoining the insured address is not subject to any communal or common property conditions (e.g. community title/strata title arrangements). The insured address does not include common property **unless** the additional feature 'Contents on common property' applies.

What we cover as your property

Your property means the residential building that you own or are responsible for and used by tenants primarily for domestic purposes and including the following at the insured address:

- garages, carports, outbuildings, outdoor walls, gates, fences (limit applies) and any structural improvements on land;
- decks, pergolas, pagodas, verandas and balconies, fixed water tanks, fixed swimming pools and spas, granny flats, sheds, tennis courts;
- garden borders, pathways and paved or concreted floor areas;
- driveways or sealed roads (limits apply);
- retaining walls which are located within the boundaries of the insured address;
- services, both above and below ground that you own and you are responsible for;
- any permanently housed, connected or wired electrical appliances;
- any permanently fixed outdoor items, including solar panels, satellite dish, play equipment, clothes lines, animal housing and outdoor lights;
- gas appliances permanently plumbed to a gas supply;
- any permanently attached fixtures including wall, ceiling and floor coverings;
- lino installed, whether permanently attached or not;
- sewer storage tanks or treatment tanks permanently plumbed to your property;
- boat jetties, pontoons, mooring poles and their attachments and accessories which are located within the boundaries of the insured address or where part of their structure begins or terminates on the insured address;
- any uninstalled building fittings, fixtures and materials (limits apply) **but only** when kept in a locked and secured building at the insured address.

What we do not cover as your property

Your property does not include:

- anything defined as contents;
- any new building in the course of construction;
- any temporary or mobile structures, including caravans, houseboats, watercraft or motorised vehicles or craft of any type;
- inflatable or portable swimming pools and spas and their accessories;
- any fixed or temporary dead weight moorings, mushroom moorings or screw in moorings;
- any carpets, rugs, blinds, drapes or curtains;
- air conditioners attached within a window;
- loose or compacted soil, lawn, artificial grass, gravel, pebbles, rocks or granular rubber;
- used or applied chemicals, fertilisers or pesticides;
- plants, trees and shrubs or hedges in the ground (unless covered under additional feature 'Damage to gardens and plants');
- a hotel, motel, boarding or guest house.

The most we will pay for property claims

If we accept your claim, the most we will pay for loss or damage to your property is the sum insured shown on your certificate of insurance, unless a different limit elsewhere in your policy applies. Some items also have fixed limits that cannot be increased and these limits are the most we will pay for these items as shown in the table below.

| Fixed limits apply to | Limits for any one insured incident |
|--|-------------------------------------|
| Uninstalled building fittings, fixtures and materials (e.g. tiles stored in the shed or an oven that is not yet installed) | Up to \$500 in total |
| Fencing* | Up to 2 kilometres |
| Driveway and sealed roads* | Up to 500 metres |

*In addition to the distance limit shown we will not pay more than the property sum insured shown on your certificate of insurance.

What we cover as your contents

Your contents means unfixed household goods and furnishings that you own or are legally responsible for and which are at the insured address for your tenant's domestic use such as:

- carpet and rugs (fixed and unfixed);
- internal blinds and curtains;
- manchester and linen;
- furniture and furnishings;
- paintings, pictures, works of art, antiques, sculptures and art objects;
- TVs, stereos, VCR and DVD players and non-portable entertainment systems;
- portable heaters and vacuum cleaners;
- cutlery, crockery and kitchenware;
- household tools and gardening equipment including ride-on mowers;
- washing machines, dryers, refrigerators and mobile dishwashers;
- plants in pots;
- inflatable or portable swimming pools and portable spas and their accessories.

If contents are insured in a unit

Contents also includes the fittings in a unit if the fittings are not legally part of the building according to the relevant state law. The fittings included are limited by law, and depending on the location of your unit could be:

- lino installed in the unit, whether permanently attached or not;
- floating wooden floors;
- air conditioners and spas for the sole use of the tenants of the unit;
- wall paint and paper if your unit is located in New South Wales.

We will not cover any item which is legally part of a unit according to the relevant state law.

What we do not cover as your contents

Contents does not include:

- personal effects and valuables designed to be worn or carried by a person such as:
 - footwear, baggage, handbags, wallets, furs;
 - jewellery, watches, clothing;
- valuable items such as:
 - cash, smart cards, phone cards, documents able to be cashed or traded, vouchers, money orders or stamps;
 - medals, collections or memorabilia;
 - items made of, or plated with, gold or silver;
 - precious stones;
- musical instruments, sporting or recreational equipment (including bicycles and firearms);
- portable battery operated appliances such as: tablets, cameras, mobile phones, iPods, MP3 players;
- recorded, saved or stored audio, video, data or media. This includes the device, object or place where they are recorded, saved or stored;
- computers (see meaning on page 56) and their printers or software;
- electrical and gas appliances, light fittings, alarm systems permanently connected or plumbed to the electricity or gas supply;
- dishwashers housed in a cabinet;
- lawns, trees, shrubs, plants, hedges;
- fixed swimming pools or spas and their accessories;
- water in tanks, swimming pools, spas or any other water container;
- animals, including fish, reptiles, pets and livestock;
- business equipment;
- unfixd home building materials and uninstalled home fittings;
- loose or compacted soil, lawn, artificial grass, gravel, pebbles, rocks or granular rubber (e.g. sand on tennis courts or gravel driveways);
- motor vehicles, motorcycles, mini-motorcycles or motorised bicycles, watercraft, aircraft, or any accessories for these vehicles or craft;
- caravans, mobile homes or any of their contents;
- any item forming part of your property for insurance purposes or which is legally part of a unit building;
- contents in storage at the insured address which are not for the tenant's use.

The most we will pay for contents claims

If we accept your claim the most we will pay for the loss or damage to all contents arising from any one insured incident is the contents sum insured shown on your certificate of insurance.

There are also limits that apply to individual content items or types of items. These limits are set out in the table below 'Contents with fixed limits'.

Contents with fixed limits

The following table lists contents that have fixed limits that cannot be changed and these limits are the most we will pay for those contents items.

| Item | Limit for any one insured incident |
|--|--|
| Paintings, pictures, works of art, antiques, sculptures, ornaments and art objects | Up to \$2,000 for each item or set up to \$10,000 in total |
| Carpets or rugs that are hand woven | Up to \$2,000 per carpet or rug |

GST

Limits and the most we pay amounts stated in this PDS and on your certificate of insurance include GST.

What you are covered for – Insured events

If you have a property insurance policy, we cover your property for loss or damage at the insured address caused by an insured event during the period of insurance.

If you have a contents insurance policy, we cover your contents for loss or damage at the insured address caused by an insured event during the period of insurance.

There are some things we do not cover and these are shown in the 'We do not cover' section of the following tables on pages 17 to 24 and in the 'General exclusions' on pages 38 to 42.

Flood

We cover

Loss or damage caused by flood.

'Flood' means the covering of normally dry land by water that has escaped or been released from the normal confines of any of the following:

- a) a lake (whether or not it has been altered or modified);
- b) a river (whether or not it has been altered or modified);
- c) a creek (whether or not it has been altered or modified);
- d) another natural watercourse (whether or not it has been altered or modified);
- e) a reservoir;
- f) a canal;
- g) a dam.

We do not cover

- loss or damage caused by actions or movements of the sea or by storm surge;
- loss or damage to retaining walls, sea walls, garden borders and free standing outdoor walls;
- resultant cracking to paths, driveways, any outdoor surfaces, **but we will cover** them if they are washed away by the flood;
- loss or damage to a sporting surface or court;
- loss or damage to boat jetties, pontoons, mooring poles and their attachments and accessories, including if they are washed away by flood;
- the cost of cleaning mud or debris out of tanks, swimming pools or spas, including replacing or storing the water;
- damage to paintwork of your property, if that is the only building damage caused by the flood;
- loss or damage to swimming pools or underground tanks caused by water leaking down the sides, against the sides or getting underneath them;
- loss or damage to gates, fences or wall fences that were in a state of disrepair which would have been obvious to a reasonable person before the damage occurred;
- loss or damage caused by erosion, vibration, subsidence, landslip, landslide, mudslide, collapse, shrinkage or any other earth movement, **but we will cover** damage caused by landslide or subsidence that occurs within **72** hours of, and directly because of, flood and not because of erosion over time, structural fault or design fault;
- the cost of cleaning your property or contents at the insured address.

Storm

We cover

Loss or damage caused by a storm.

We do not cover

- loss or damage caused by actions or movements of the sea or storm surge, **but we will cover** loss or damage caused by storm surge if it occurs at the same time as other insured damage at the insured address caused by storm;
- loss or damage caused by erosion, vibration, subsidence, landslip, landslide, mudslide, collapse, shrinkage or any other earth movement, **but we will cover** loss or damage caused by a landslide or subsidence that occurs within **72** hours of, and directly because of, a storm and not because of erosion over time, structural fault or design fault;
- loss or damage to retaining walls, sea walls, garden borders and free standing outdoor walls;
- resultant cracking to paths, driveways, any outdoor surfaces, **but we will cover** them if they are washed away by the storm;
- loss or damage to a sporting surface or court;
- loss or damage to boat jetties, pontoons, mooring poles and their attachments and accessories, including if they are washed away by the storm;
- the cost of cleaning mud or clearing debris out of tanks, swimming pools or spas, including replacing or storing the water;
- loss or damage to swimming pools or underground tanks caused by water leaking down the sides, against the sides or getting underneath them;
- damage to paintwork of your property, if that is the only building damage caused by the storm;
- loss or damage to gates, fences or wall fences that were in a state of disrepair which would have been obvious to a reasonable person before the loss or damage occurred;
- the cost of cleaning your property or contents at the insured address.

Lightning

We cover

Loss or damage caused by lightning, including power surge caused by lightning.

We do not cover

- any claim where the Australian Government Bureau of Meteorology has no record of lightning in your area at the time of the loss or damage;
- loss or damage without written confirmation from a qualified repairer saying lightning was the actual cause of the loss or damage;
- loss or damage caused by power failures or surges by your power provider.

Fire

We cover

Loss or damage caused by fire (burning with flames).

We do not cover

Loss or damage arising from:

- heat, ash, soot and smoke when your property or contents has not caught on fire **unless** it is caused by a burning building within **10** metres of the insured address;
- arcing, scorching or cigarette burns **unless** a fire spreads from the initial burn spot;
- pollution or vapour from a home heater or a cooking appliance **unless** a fire spreads from the initial source.

Earthquake and Tsunami

We cover

Loss or damage caused by an earthquake or tsunami.

We do not cover

- loss or damage caused by actions or movements of the sea or storm surge.
Note: 'Tsunami' is not an action or movement of the sea, see page 56.
- loss or damage that occurs more than **72** hours after an earthquake or tsunami;
- loss or damage caused by erosion, vibration, subsidence, landslip, landslide, mudslide, collapse, shrinkage or any other earth movement, **but we will cover** damage caused by a landslide or subsidence that occurs within **72** hours of, and directly because of, an earthquake or tsunami and not because of erosion over time, structural fault or design fault.

Theft or burglary by tenants or their guests

We cover

Loss or damage caused by theft or burglary by your tenants or their guests.

Note:

An additional excess applies. See page 46 for more details.

We do not cover

Loss or damage when we have accepted a previous claim under this insured event in the same period of insurance in relation to the same tenant.

Note:

'Same tenant' means that at least one common person was usually residing at the insured address at the time of both insured events.

Theft or burglary by people who are not tenants or their guests

We cover

Loss or damage caused by thieves or burglars who are not your tenants or their guests.

We do not cover

Loss or damage caused by you or your tenants or their guests.

Accidental breakage of glass

We cover

When you have property cover

Accidental breakage of:

- fixed glass in windows, doors, skylights, mirrors fixed to your property and other fixed glass (including glass tint if fitted);
- glass in a fixed light fitting in your property;
- sinks, basins, baths or shower-bath combinations, cisterns and toilets;
- any glass that forms part of a:
 - fixed cooking or heating appliance; **or**
 - cook top or cooking surface;**but we will not pay** to replace the entire appliance, cook top or cooking surface.

When you have contents cover

Accidental breakage of:

- glass that forms part of the furnishings at the insured address for the tenant's use;
- fitted glass in furniture and unfixed hung mirrors.

Replacing glass

We will also cover the frame of any window, door or shower screen, **but only** if this is necessary to enable the glass to be replaced.

We do not cover

When you have property cover

- any accidental breakage which has occurred while the items are outside your property **unless** stated otherwise;
- glass in a glasshouse, greenhouse or conservatory;
- ceramic tiles;
- shower bases (tiled or otherwise);
- the cost to modify any part of your property to fit the replacement cooking or heating appliance if the dimensions differ;
- the cost to remove broken glass from carpets or other parts of your property;
- any loss or damage if the breakage does not extend through the entire thickness of the damaged item (e.g. chips or scratches).

When you have contents cover

- drinking glasses and any glass or crystal items normally carried by hand;
- any hand held mirrors;
- the screen or glass of any television set or other type of visual or audio electronic device;
- glass that is part of a vase, decanter, jug, fishbowl, ornament or light globe;
- the cost to remove broken glass from carpets or other parts of your property or contents;
- any loss or damage if the breakage does not extend through the entire thickness of the damaged item (e.g. chips or scratches).

Escape of liquid

We cover

Loss or damage caused by liquid leaking, overflowing or bursting from any of the following:

- refrigerators, freezers, dishwashers and washing machines;
- any drain, fixed pipes, roof gutters or guttering and rainwater downpipes, drainage and sewage systems;
- fixed tanks;
- swimming pools or spas;
- waterbeds;
- baths, sinks, toilets and basins;
- fixed heating or cooling system;
- water main, fire hydrant or water supply pipe;
- an aquarium.

Exploratory costs

We will pay the reasonable cost of locating, at the insured address, the source of the escaped liquid and to repair and restore the damage to your property and contents caused by our exploratory work, **but only** if the escape of liquid is covered under this insured event. If the leak is not covered under this insured event, we provide some limited cover for exploratory costs under additional cover 'Exploratory costs where a leak is not covered under insured event 'Escape of liquid''. See page 32.

If we pay for damage or exploratory costs under this insured event, we will also pay up to **\$750** extra to match or complement undamaged materials in the same room, hallway, stairs or passageway* where the damage occurred. See page 49.

We do not cover

- wear and tear, or loss or damage by the escape of liquid occurring as a result of a gradual process of leaking, splashing, dripping or overflowing over a period of time when you could reasonably be expected to be aware of this condition;
- the cost of repairing or replacing the item from which the liquid escaped;
- fixing leaks that have not caused permanent damage to your property;
- leaks from agricultural pipes;
- loss or damage caused by liquid from a portable container, such as plant pot, vase, terrarium, fishbowl, beverage container, saucepan, bucket or watering can;
- loss or damage caused by liquid from a watering system or hose;
- loss or damage to retaining walls;
- loss or damage to, or caused by, a leaking shower floor or base, shower cubicle walls, shower glass screening or doors;
- costs if you repair or renovate a damaged area of your property before we can inspect it and find the cause;
- broken, worn or aged tiles or grouting in walls in bathrooms, kitchens or laundries **unless** the damage is caused by liquid leaking from pipes in walls or floors (not forming part of a shower cubicle wall, floor or base);
- loss or damage caused by wear, tear, rust, fading, rising damp, mould, mildew, corrosion, rot;
- loss or damage caused by storm surge.

Impact

We cover

Loss or damage caused by impact at the insured address from:

- a falling tree or part of a falling tree including the roots;
- power poles;
- TV antennas or satellite dishes, communication aerials or masts;
- watercraft, aircraft, motor vehicles or trailers;
- an object falling from a motor vehicle or aircraft;
- space debris or meteorites.

We do not cover

- loss or damage to driveways, paths, paving or underground services caused by a road vehicle, crane or earthmoving equipment;
- any portion of a fence or wall that is not owned by you;
- the cost of removing or lopping fallen trees or branches that have not damaged your property or contents;
- loss or damage caused by trees being lopped, felled or transplanted by you or someone authorised by you;
- the removal of tree stumps or roots still in the ground.

Damage by an animal

We cover

Loss or damage caused by an animal.

We do not cover

Loss or damage caused by:

- any animal owned by or in the custody of you, your tenant, or someone who is at the insured address with your consent or the consent of the tenant;
- insects, vermin or rodents, **but we will cover** damage they cause if it is covered under the following insured events:
 - ‘Fire’ (see page 19);
 - ‘Escape of liquid’ (see page 21);
- animals pecking, biting, clawing, scratching, tearing or chewing your property or contents, or damage caused by their urine or excrement. **But we will cover** damage caused by an animal (**except** insects, vermin or rodents) which becomes accidentally trapped inside the insured address and which does not belong to you or anyone living at the insured address.

Explosion

We cover

Loss or damage caused by an explosion.

We do not cover

- the cost of repairing or replacing the tank or container that exploded;
- loss or damage caused by nuclear or biological devices;
- loss or damage caused by erosion, vibration, subsidence, landslip, landslide, mudslide, collapse, shrinkage or any other earth movement, **but we will cover** loss or damage caused by a landslide or subsidence that occurs within **72** hours of, and directly because of, an explosion and not because of erosion over time, structural fault or design fault.

Riot, civil commotion or public disturbance

We cover

Loss or damage caused by riot, civil commotion or public disturbance e.g. damage caused by a violent crowd moving down your street.

We do not cover

This box has been left blank intentionally.

Malicious acts or vandalism by tenants or their guests

We cover

Loss or damage caused by malicious acts or vandalism by your tenants or their guests.

Note: An additional excess applies. See page 46 for more details.

We do not cover

- accidental or unintended loss or damage;
- the cost of cleaning, repairing or restoring your property or contents caused by neglect, or untidy, unclean or unhygienic habits of the tenant or their guests, such as the cost of cleaning, repairing or removing:
 - liquid (including urine) or food stains;
 - odours;
 - abandoned items or rubbish;
 - drawing or painting on walls;
 - water damage and stains from over-watering plants;
 - water damaged carpets, flooring, cupboards or vanity units caused by water splashing from showers, sinks or baths.
- loss or damage when we have accepted a previous claim under this insured event in the same period of insurance in respect of the same tenant.

Note:

'Same tenant' means that at least one common person was usually residing at the insured address at the time of both insured events.

Malicious acts or vandalism by people who are not tenants or their guests

We cover

Loss or damage caused by malicious acts or vandalism by people who are not your tenants or their guests.

We do not cover

Loss or damage caused by you or your tenants or their guests.

Refer to the PED Guide for further information

Additional features

If we accept your claim for loss or damage due to an insured event, we will also provide the following additional features. The additional features and their limits are paid in addition to the sum insured for your property and contents. There are some things we do not cover under these additional features and these are shown in the 'We do not cover' section of the following tables on pages 25 to 28 and in the 'General exclusions' on pages 38 to 42. All of the conditions of this policy apply to these additional features unless the cover says otherwise.

Loss of rent following an insured event

We cover

When you have property cover

If we accept your claim for loss or damage to your property due to an insured event occurring during the period of insurance and we agree it cannot be lived in, we will pay the weekly rental amount for the reasonable amount of time we decide it should take to repair or rebuild the property so it can be lived in again.

When you have contents cover in a unit

If we accept your claim for loss or damage to your contents due to an insured event occurring during the period of insurance and the insured address is a unit and we agree the insured address cannot be lived in, we will pay the weekly rental amount for the reasonable amount of time we decide it should take to repair or rebuild the unit so it can be lived in again.

The longest period we will provide cover for is **52** weeks and the most we will pay under the feature is:

- **10%** of the property sum insured for a property claim; **or**
- **10%** of the contents sum insured for a contents claim.

We do not cover

- loss of rent:
 - if you do not intend to repair or replace the property, unit or contents;
 - if the tenant still has an obligation to pay the rent;
 - once the insured address is able to be lived in again;
 - if you have made a claim for the same event under 'Loss of rent – tenant default';
 - if the insured address was not occupied by a paying tenant at the time the loss or damage occurred. **But we will** provide cover if we decide it would have been rented, and you give us evidence of this, during the time taken to repair, replace or rebuild the property or unit;
- any amounts you are able to recover for loss of rent under another insurance policy including any insurance policy taken out by a body corporate or similar entity.

Removal of debris

We cover

When you have property cover

The reasonable and necessary costs of:

- demolishing and removing the damaged parts of your property from the insured address;
- removing debris when required in order to repair your property.

The most we will pay for any one event is **10%** of the property sum insured.

When you have contents cover

The reasonable and necessary costs to dispose of the damaged contents.

The most we will pay for any one event is **10%** of the contents sum insured.

We do not cover

When you have property cover

The cost of:

- removing tree stumps and roots still in the ground;
- removing any debris, including fallen trees or fallen branches that have not damaged your property.

When you have contents cover

Disposal, storage or removal of anything that is not defined as contents.

Other repair/rebuilding costs

We cover

When we are rebuilding or repairing damaged parts of your property, we will pay the reasonable and necessary costs:

- of any temporary work required to make the damaged or destroyed property and insured address safe;
- for the services of professionals, such as architects or surveyors, to repair or rebuild at the insured address;
- to make the damaged parts of your property comply with the current building regulations and laws.

The most we will pay for any one event is **10%** of the property sum insured.

We do not cover

The costs of:

- removing tree stumps and roots still in the ground;
- removing or lopping fallen trees or fallen branches that have not damaged your property;
- upgrading undamaged parts of your property to comply with the current building regulations and laws;
- making your property comply with building regulations and laws that existed but were not complied with when your property was originally built or altered.

Environmental improvements

We cover

We provide cover for the costs associated with the purchase and installation of environmental improvements at the insured address such as a rainwater tank, solar system or compost equipment when all of the following applies:

- we have accepted a claim for an insured event that has caused loss or damage worth more than **80%** of your property sum insured; **and**
- your property does not already have the relevant environmental equipment; **and**
- we are authorising or arranging the repairs to your property; **and**
- you have sought our agreement prior to purchasing or installing the relevant environmental equipment.

The most we will pay is up to **\$2,500** of your net costs* in purchasing and installing the approved environmental equipment.

*Net cost is the amount you spend after deducting any government subsidy to which you are entitled at the date of the loss, whether you claim this subsidy or not. You must supply us with proof of the amount you spent before we will pay you.

We do not cover

Any amount covered under 'Other repair/rebuilding costs' to comply with the latest building regulations.

Storage of undamaged contents

We cover

If you make a claim for loss or damage to your contents due to an insured event, and we agree that the undamaged contents cannot be kept at the insured address, we will also pay the reasonable cost to store the undamaged contents until the contents can be kept at the insured address.

The most we will pay for storage of undamaged contents is **10%** of the contents sum insured.

Note:

We will pay for any loss or damage to the undamaged contents caused by an insured event while they are at the place of storage **but only** up to the contents sum insured shown on your certificate of insurance (less any amount paid for loss or damage to your contents as part of the original claim). This cover stops when your policy is cancelled, lapses or we stop paying for storage, whichever happens first. All the conditions, limits and exclusions of this policy apply to this cover.

We do not cover

- storage costs once we decide the contents could be returned to the insured address;
- storage of contents outside of Australia;
- loss or damage that is excluded by this policy.

Damage to gardens and plants

We cover

We will pay the cost of replacing trees, shrubs, plants, hedges or garden beds at the insured address with ones that we consider are reasonably similar to the ones lost or damaged if:

- the trees, shrubs, plants, hedges or garden beds at the insured address are damaged as a result of an insured event; **and**
- we have accepted a claim for loss or damage to your property resulting from the same insured event.

We will pay up to **\$1,000** for any one event.

We do not cover

Loss or damage

- to lawns, grass or pot plants;
- caused by the following insured events:
 - ‘Storm’ (see page 18);
 - ‘Flood’ (see page 17);
 - ‘Escape of liquid’ (see page 21).

Mortgagee’s discharge costs

We cover

If you have property cover and we pay a claim for your property to a credit provider that fully repays your property loan, then we will pay the administrative and legal costs of:

- discharging the mortgage;
- removing the mortgagee from the land title on your property.

The most we will pay under this additional cover in any one period of insurance is **\$1,000**.

We do not cover

- penalty interest rate charges or early loan repayment charges imposed on you by the credit provider.

Refer to the PED Guide for further information

Additional covers

We also provide the cover set out under the following additional covers. A claim under an additional cover can be made independently of a claim for loss or damage to your property or contents.

The cover provided is shown in the 'We cover' section of the following tables on pages 29 to 32. In all cases the incident that causes the loss or damage must happen in the period of insurance.

There are some things we do not cover and this is shown in the 'We do not cover' section of the following tables on pages 29 to 32 and in the 'General exclusions' on pages 38 to 42. All of the conditions of this policy apply to these additional covers unless the cover says otherwise.

Loss of rent – tenant default

This additional cover only applies when you have property cover or you have insured your contents in a unit

There is **no cover** provided under this additional cover for an amount equal to four (4) times the weekly rental amount **except** when your claim relates to the death of a sole tenant (see item 3 below).

In addition, an excess of **\$500** applies to a claim made under items 1 or 2 below. The standard excess **does not** apply.

We cover

1. If your tenant stops paying the weekly rental amount during the term of your written rental agreement, or periodic rental agreement, and during the period of insurance **but does not leave**, we will pay the weekly rental amount for a period:
 - up to **14** weeks if you have a written rental agreement; **or**
 - up to **2** weeks if you have a periodic rental agreement.We will deduct from your claim any amount paid to you as rent. The most we will pay in total under this cover is **\$5,000**. Cover stops when the tenant is no longer in rent arrears.
2. If your tenant permanently leaves during the period of insurance without giving you written or verbal notice as required under your written rental agreement or periodic rental agreement, we will pay the weekly rental amount if it is not paid to you for a period:
 - up to **14** weeks for a written rental agreement or until the date of a new rental agreement (whichever happens first); **or**
 - up to **2** weeks for a periodic rental agreement or until the date of a new rental agreement (whichever happens first).We will deduct from your claim any amount paid to you as rent. The most we will pay in total under this cover is **\$5,000**.
3. If your tenant is a sole tenant and that person dies during the period of insurance and before the end of their tenancy we will pay the weekly rental amount from the date of their death or the date the rent is paid up to (whichever is the later date) for up to **2** weeks.

We will not pay if the sole tenant had given you or your agent notice in accordance with the written rental agreement or periodic rental agreement prior to their death.
4. If your written rental agreement is legally terminated by a Residential Tenancies Tribunal or another relevant authority on the grounds of hardship on the part of the tenant during the period of insurance, we will pay the weekly rental amount from the date the termination order takes effect for up to a further **4** weeks or until you secure a new tenant, whichever happens first.

We do not cover

Loss of rent if:

- we have paid a previous claim under this additional cover in respect of the same tenant in the same period of insurance;
- you do not have a rental agreement in place;
- you have not taken all reasonable steps legally available to you under the Residential Tenancies Act, or other relevant State or Territory Legislation, to remedy non-payment and/or evict the tenant;
- the tenant has not breached your rental agreement;
- the written rental agreement could have been legally terminated by you;
- the rent was in arrears when you took out this policy;
- you have made a claim for ‘Loss of rent – insured event’ for the same incident;
- you do not actively seek a new tenant.

Note:

‘Same tenant’ means at least one common person was usually residing at the insured address both times the rent ceased being paid.

Legal costs to recover unpaid rent

A standard excess **does not** apply to this additional cover.

We cover

If we accept and pay your claim under ‘Loss of rent – tenant default’ **and** you have a written rental agreement **and** before incurring any legal costs you obtained our permission in writing to incur legal costs to recover unpaid rent, we will pay the reasonable:

- legal costs to recover the rent owed to you; **and**
- costs charged by your agent for attending a court or tribunal to try to recover the unpaid rent.

The most we will pay for all claims against any one tenant is **\$5,000** in total. You must repay us any rent you recover that we previously paid under ‘Loss of rent – tenant default’.

We do not cover

Legal costs:

- not related to recovering rent from the tenant;
- if we have paid a previous claim under this additional cover in respect of the same tenant.

Note:

‘Same tenant’ means at least one common person was usually residing at the insured address both times the rent ceased being paid.

Loss of rent – prevention of access

This additional cover only applies when you have property cover or you have insured your contents in a unit

We cover

We will pay the weekly rental amount if we agree your tenant does not have access to the insured address due to one of the following incidents:

- damage to a building, the strata title property in which the unit is located, or a road or street providing access to the insured address;
- burst water main;
- bomb threat or bomb damage;
- street riot;
- emergency services refusing your tenant access to the insured address or evacuating the tenant for safety reasons.

We will provide cover until the date the insured address becomes accessible, up to a maximum of **14** weeks or **\$4,000**, whichever is less.

We do not cover

Loss of rent:

- if the insured address was not occupied by a paying tenant at the time the insured address became inaccessible. **But we will** provide cover if we decide it would have been rented during the time that access to the insured address was prevented, and you give us evidence of this;
- once the insured address is able to be accessed again;
- if your property or unit is damaged;
- caused by the threat of, or damage by, a nuclear or biological bomb.

Damage from physical injury or incident

We cover

When you have property or contents cover we cover damage to and/or soiling of your:

- property if you have property cover;
- contents if you have contents cover;

as a result of:

- physical assaults or death whether natural, suicide or murder;
- forensic or police investigations into the above.

Also included are the costs of:

- specialist forensic and other cleaning services;
- removal of bio-hazard materials.

The most we will pay for any one incident is **\$15,000**.

We do not cover

- damage or soiling caused by incidents which are not the result of physical assaults or death;
- odour removal.

Lock replacement

We cover

If you have property or contents cover we will cover the costs of rekeying or replacing (whichever is the lesser) locks and cylinders on external doors and windows of the insured address if your tenant:

- leaves the insured address before the end of the rental period stated in your written rental agreement without giving you or your agent the notice required by the written rental agreement; **or**
 - is legally evicted from the insured address;
- and the tenant has not returned the keys to you or your agent.

The most we will pay for any one incident is **\$800**.

If you make a claim under this additional cover no excess applies.

We do not cover

The cost of replacement of the keys.

Exploratory costs where leak is not covered under insured event 'Escape of Liquid'

We cover

If you have property cover we will pay the cost to locate the source of liquid escaping or overflowing at the insured address and to repair and restore the damage to your property caused by our exploratory work if the escape of liquid first happens during the period of insurance.

The most we will pay is **\$1,500** for each incident.

If you make a claim under this additional cover, no excess applies.

We do not cover

This box has been left blank intentionally.

Contents on common property

We cover

If you insure your contents in a unit under this policy, we will cover your contents permanently fixed on or to common property of the residential complex on the same basis as if they were at the insured address.

The most we will pay for any one event is **\$1,000**.

We do not cover

Loss or damage:

- for which your body corporate is liable;
- to any item not owned solely by you.

Refer to the PED Guide for further information

Optional covers

You can ask us to add one or more of the following optional covers to your policy for an extra premium. If you have an optional cover, that option will be shown on your certificate of insurance and the cover provided is as shown in the 'We cover' section of the following tables on pages 33 to 35.

There are some things we do not cover and this is shown in the 'We do not cover' section of the following tables on pages 33 to 35 and in the 'General exclusions' on pages 38 to 42. All of the conditions of this policy apply to optional covers unless the cover says otherwise.

Motor burnout

We cover

The burning out or fusing of electric motors, that happens in the period of insurance, in household equipment or appliances which are part of your:

- property if you have property cover;
- contents if you have contents cover;

and are equal to or less than **10** years old.

Cover includes the reasonable cost to repair or replace:

- the electric motor or compressor containing the motor;
- an entire sealed unit, filter, dryer and re-gassing if the electric motor is inside a sealed refrigeration or air conditioning unit;
- a swimming pool water pump, combined with its electric motor, if the replacement pump motor cannot be bought on its own.

If an electric motor or motor in an appliance cannot be repaired or replaced, we will pay the replacement cost of an equivalent motor or motor in a sealed unit of the same specification and standard available today. We will not pay for the replacement of the whole appliance **unless** it costs us less than it would to repair or replace the motor.

We do not cover

- the cost of extracting or reinstalling a submersible pump;
- any amount you can recover under a manufacturer's guarantee or warranty;
- loss or damage to motors forming part of equipment used in conjunction with your trade, business activity or occupation;
- loss or damage to a refrigerator or freezer caused by food spoilage.

Accidental damage at the property

We cover

Your property or contents for accidental loss (e.g. losing something) and accidental damage (e.g. breaking or damaging something) during the period of insurance.

Even though these are not covered under the insured events on pages 17 to 24, this option also covers, for example:

- the cost of removing glass fragments from your property or contents items;
- accidental damage:
 - to ceramic tiles;
 - to drinking glasses, decanters, jugs and any glass or crystal items carried by hand;
 - to a TV screen;
 - to glass that is part of a radio or clock, vase, ornament, lamp or hand-held mirrors;
 - caused by watering systems and hoses if it happens suddenly as the result of one incident;
 - by scorching with a hot object even though there is no fire, **but not** scorching or burning by cigars, cigarettes or pipes and **not** loss or damage that is otherwise excluded by insured event 'Fire' (see page 19);
 - caused by animals or birds **but not** damage from pecking, biting, clawing, chewing, urine or excrement and **not** loss or damage caused by insects, vermin or rodents or otherwise excluded by insured event 'Damage by an animal' (see page 22).

Note:

Accidental loss or damage not excluded by your policy is an 'insured event' (see the meaning of insured event on page 57). If we accept a claim under this optional cover, the incident giving rise to the claim is an insured event. This means that you may be entitled to additional features (see pages 25 to 28 for the additional features).

We do not cover

- other than as shown above, loss or damage is not covered under this option if it is excluded elsewhere in this policy (e.g. under an insured event, an additional feature, an additional cover, an optional cover or a general exclusion);
- loss or damage caused by storm surge (limited cover is provided only under insured event 'Storm' (see page 18));
- swimming pool liners or covers;
- remote controlled:
 - model aircraft;
 - watercraft;
 - vehicles;
 - toys;
- contents away from the insured address;
- loss or damage caused by:
 - failure or shutdown of the electricity supply from any cause or spoilage of food resulting from this;
 - wear, tear, gradual deterioration, mould, rising damp, mildew, action of light, atmospheric or climatic conditions, rust, corrosion, wet or dry rot;
 - building, renovating or altering your property, **except** for spilling paint.

Strata title mortgage protection

We cover

This optional cover is only available with contents insurance in a unit you own.

If your insured address is a strata title property and it suffers loss or damage caused by an insured event during the period of insurance and both of the following applies:

- the body corporate building insurance either does not extend to covering the insured event or does not fully cover the cost of repairing or rebuilding the building; **and**
- the mortgagee on your strata title property makes a claim under your body corporate policy for repayment of the mortgage;

then we will pay to the mortgagee the lowest of these two amounts:

- where the cost of repairs is greater than the limit of cover under your body corporate insurance, the difference between the amount covered by the body corporate insurance and the cost of repairing the damage;
- the amount to fully repay your mortgage for the unit at the time of the loss or damage.

Note:

This cover may not be available to all new insurance policies.

We do not cover

- additional features on pages 25 to 28;
- additional covers on pages 29 to 32;
- any incident not covered by your contents policy.

Safety net protection

We cover

When you have property cover

When your property is damaged by an insured event during the period of insurance and the cost of repairing or replacing it exceeds the sum insured, if we have accepted your claim we will pay up to a further **25%** of your property sum insured to:

- repair or replace your property; **or**
- pay you what it would cost us to repair or replace your property.

Note:

The cover in safety net protection does not increase your property sum insured. Any additional feature based on a percentage of the property sum insured does not increase.

After you take out this policy, if you ever increase the size of your property or improve the quality of your property fixtures and fittings you need to tell us and review your property sum insured. If the increase to the size of your property is more than **10%** and you do not contact us, the most we will pay under this option reduces from **25%** to **12.5%** of your sum insured.

Refer to the PED Guide for further information

Legal Liability

The most we will pay for all claims from any one incident for legal liability covered by this policy is **\$20 million**, including all associated legal costs we have agreed to pay following your claim.

Property legal liability

If you have property cover we cover your legal liability to pay compensation for death or bodily injury to other people or loss or damage to their property resulting from an incident which happens during the period of insurance:

- in connection with your ownership of your property; **and**
- at the insured address.

Contents legal liability

If you have contents cover we cover your legal liability to pay compensation for an incident causing death or bodily injury to other people, or loss or damage to their property which happens during the period of insurance:

- in connection with you owning the unit or contents at the insured address; **and**
- in the unit or in the common property at the insured address.

What we do not cover

We do not cover legal liability caused by or arising from:

Agreements you enter into

any agreement or contract you enter into, **but we will cover** your legal liability if it would have existed had you not entered into the agreement or contract.

Aircraft

using or owning any aircraft.

Animals

any animal including a domestic dog or cat belonging to either you or your tenant.

Asbestos

exposure to or potential exposure to asbestos in any form.

Building, altering or renovating

building work being carried out at the insured address where the total cost of building, altering, extending or renovating is more than **\$50,000**.

Business activity

any business activity, **unless** this income is from the tenancy of the insured address or part of the insured address.

Caravans and trailers

using or owning a caravan, mobile home or trailer.

Committee members or officials

your actions or duties as a committee member or director of a club or association, as a coach, referee or official at a game or organised sporting activity.

Death or injury

death or injury of:

- you;
- a child (born or unborn) under **18** years who is your child or the child of your spouse, de facto or partner;
- your pets;
- anyone who usually lives with you in your usual place of residence **unless** the person is:
 - a tenant of your property or unit and not a person under **18** who is:
 - your child; **or**
 - the child of your spouse, de facto or partner.

Fines, penalties and other damages

civil or criminal penalties or fines or aggravated, exemplary, punitive or multiple damages.

Illness or disease

illness, disease or sickness you knowingly spread or failed to take due care to prevent spreading after you knew about it.

Legal actions in other countries

legal actions or legal claims brought against you, decided or heard in countries outside Australia or New Zealand.

Libel or slander

libel or slander.

Motor vehicles or motorcycles

the use or ownership of a motor vehicle or motorcycle or instructing someone on how to use it **unless** at the time of the incident the vehicle was:

- being used for domestic gardening (e.g. ride-on mowers); **and**
- did not require compulsory third party insurance.

Property owned by you or property in your physical or legal custody

damage to property which:

- is owned by you or your family;
- belongs to someone else and is in your physical or legal custody or control.

Watercraft

using or owning any watercraft.

Your employees

death or injury of your employees or damage to their property while they are working for you.

Refer to the PED Guide for further information

General exclusions

You are not covered under any section of this policy for damage, loss, cost or legal liability that is caused by, arises from or involves:

Actions of the sea

any actions or movements of the sea.

Aircraft shock waves

the gradual effects of vibrations, or shock waves caused by aircraft travelling at high speeds unless you can clearly show us that the damage was caused by a single destructive incident (e.g. sonic boom).

Biological, chemical, other pollutant or contaminant

- any actual or threatened biological, bacterial, viral, germ, chemical or poisonous substance, pollutant or contaminant; **or**
- any looting or rioting following the actual or threatened release of any biological, bacterial, viral, germ, chemical or poisonous substance, pollutant or contaminant; **or**
- any action taken by a public authority to prevent, limit or remedy the actual or threatened release of any biological, bacterial, viral, germ, chemical or poisonous substance, pollutant or contaminant.

But we will cover:

- fire damage that is covered by insured event 'Fire' (see page 19);
- your legal liability under 'Legal liability' cover (see pages 36 to 37), to the extent your legal liability arises from your use of pesticides or herbicides at the insured address;
- the cost to remove asbestos or its derivatives from the insured address during repairs or rebuilding if we have accepted a claim for loss or damage to your property or contents.

Breaking the law

- you, or someone with your knowledge or permission, committing or trying to commit an unlawful or criminal offence, such as assault or malicious damage;
- your possession, supply or consumption of any illegal substances or illegal drugs;
- you not obeying any commonwealth, state, territory or local government law, including laws relating to:
 - installing smoke alarms;
 - pool fencing;
 - failing to install a balcony railing or balustrade when required;
 - dangerous goods and liquids;
 - firearms;
 - control and safekeeping of dangerous or restricted breeds of dogs, including not obeying any legal requirement to restrain a dog in public or keep it fenced in.

Building extensions, alterations or renovations

building extensions, alterations or renovations to your property or unit. Specifically we do not cover:

- damage caused by cracking, collapse, subsidence or damage to your property or contents caused fully or partially by the building work;
- damage caused by storm, flood or water entering your property or unit through openings in the walls or roof or other unfinished parts of your property or unit whether or not they are temporarily covered at the time of the damage;
- damage caused by storm or flood to any part that is not fully built;
- theft or damage by someone who enters or leaves through an unlockable part of your property or unit;
- malicious damage or vandalism to unfinished parts of your property or unit.

Bushfires, storms, floods, tsunamis in the first 72 hours of cover

a bushfire, storm, flood or tsunami in the first **72** hours of cover. **But we will cover** these events if this policy began on the same day:

- you bought your property or unit; **or**
- that another policy covering your property or contents expired, but not when you cancelled the policy prior to its expiry date, and only up to the sums insured covered under the expired policy (any increase in sums insured will not be covered for these events for the first **72** hours specified).

Chemical damage when cleaning

chemicals, such as detergents and solvents, when you or someone authorised by you is using them for cleaning.

Chips or scratches

a breakage that does not extend through the entire thickness of the damaged item (e.g. chips or scratches).

Computer virus or computer hacking

a computer virus or hacking.

Confiscation or damage by a legal authority

confiscation, nationalisation, requisition, loss or damage caused by the police, a government authority or someone with the legal authority to do this.

Consequential losses or extra costs following an incident covered by your policy

consequential loss (financial and non-financial loss) or extra costs following an incident covered by your policy, such as:

- loss of rent **except** as expressly covered by this PDS;
- loss of income or wages;
- medical expenses;
- costs, including the cost of your time (e.g. inconvenience), to prove your loss or to help us with your claim (e.g. telephone calls, postage);
- cost of hiring appliances after yours suffer loss or damage;
- professional, expert, legal, consulting or valuation costs **unless** you obtained our prior written authority to incur these costs;
- cost of replacing or reapplying pest control chemicals and baits in or around the insured address;
- travel costs;
- cleaning costs;
- loss or costs related to stress or anxiety;
- any loss or costs not covered by your policy.

General exclusions – (Cont'd)

You are not covered under any section of this policy for damage, loss, cost or legal liability that is caused by, arises from or involves:

Defect, structural fault or design fault

a defect, structural fault or design fault that you knew about (or should reasonably have known about) and did not fix before the loss or damage occurred (e.g. if there are signs that a defect previously caused damage, we will not pay a later claim for further damage from this defect).

Deliberate actions by you

any act, by you or by someone acting with your given or implied consent that:

- is deliberate;
- is a deliberate lack of action;
- demonstrates a reckless disregard for the consequences of that action or omission.

Deliberate damage to a reservoir or dam

deliberate or malicious damage to, or destruction of, a reservoir or dam, or any looting or rioting following such an incident.

Failing to take care of your property or contents

your failure to:

- take reasonable care of your property or unit and contents;
- keep your property or unit and contents in good condition and well maintained. For the meaning of 'good condition' see the 'Words with special meanings' section on pages 56 to 59;
- fix faults and defects as soon as you or your agent become aware of them.

Ground movement

erosion, vibration, subsidence, landslip, landslide, mudslide, collapse, shrinkage or any other earth movement, **but we will cover** landslide or subsidence that is specifically covered under the following insured events:

- 'Storm' (see page 18);
- 'Flood' (see page 17);
- 'Earthquake and Tsunami' (see page 19);
- 'Explosion' (see page 23).

Hazardous materials

any hazardous materials if not stored or used in accordance with the relevant law, controls and manufacturer's instructions.

Mechanical or electrical breakdown

mechanical or electrical failure or breakdown or anything that fails to operate properly, **but we will cover** damage caused by:

- fire spreading from an electrical fault to other parts of your property and contents to the extent it is covered under insured event 'Fire' (see page 19);
- lightning to the extent it is covered under insured event 'Lightning' (see page 18);
- motor burnout to the extent it is covered under 'Motor burnout' optional cover (see page 33).

Medical equipment and aids

any medical equipment, item or aid.

Not complying with building regulations

your property or unit not complying with building laws or regulations, **except** those laws or regulations introduced after your property or unit was originally built or last altered which you were not required to comply with.

Photographs, electronic data and images

repairing, replacing or fixing:

- electronic data or files that are corrupted, damaged or lost, including software, photographs, films, music or other visual images or audio files stored electronically or on any other medium, **unless**:
 - the device they were stored on is lost or damaged by an insured event; **and**
 - the electronic data or files were legally purchased and you cannot restore them free of charge.
- hard copies of photographs, films or other visual images that are damaged or lost, **but we will cover** the cost of reproducing hard copy photographs you have purchased from, or had produced by, a professional photographic business or retail outlet.

Power surge

power surge, **unless** the surge or the loss or damage caused by the surge is covered under:

- insured event:
 - ‘Fire’ (see page 19);
 - ‘Lightning’ (see page 18);
 - ‘Storm’ (see page 18);
 - ‘Flood’ (see page 17).
- ‘Motor burnout’ optional cover (see page 33).

Radioactivity

radioactivity or the use, existence or escape of:

- nuclear fuel;
- nuclear material or waste;
- action of nuclear fission including detonation of any nuclear device;
- nuclear weapon;
- any looting or rioting following such an incident.

Replacement of water

the loss, storage and replacement of water in any tank, container, pool, spa and any other water storage vessel.

Revolution, war

revolution, war or other acts of foreign enemy, war like activity (whether war is declared or not), military coup, or any looting or rioting following these incidents.

Roots of trees, shrubs and plants

the roots of trees, shrubs or plants, **but we will cover** damage to your property or contents caused by:

- liquid leaking or overflowing from pipes or drains that are blocked or damaged by these roots to the extent it is covered under insured event ‘Escape of liquid’ (see page 21);
- roots from a fallen tree to the extent it is covered under insured event ‘Impact’ (see page 22).

General exclusions – (Cont'd)

You are not covered under any section of this policy for damage, loss, cost or legal liability that is caused by, arises from or involves:

Seepage of water

water seeping or running:

- through the earth (hydrostatic water seepage);
- down the sides of earth or earth fill that is up against your property;
- down the sides or underneath swimming pools or spas causing them to move, change shape, lift or leak through their hydrostatic valves;
- against or through retaining walls and forcing them to move or crack;
- from agricultural pipes.

Storm surge

storm surge, **except** to the extent loss or damage is covered under insured event 'Storm' (see page 18).

Structural improvements at units

- structural improvements owned by your body corporate or equivalent body;
- structural improvements located on common property.

Tree lopping

trees being lopped, felled or transplanted by you or someone authorised by you.

Wear, tear and gradual deterioration

wear, tear, rust, fading, rising damp, mould, mildew, corrosion, rot, action of light, atmospheric or climatic conditions or gradual deterioration such as, **but not limited to:**

- tiles and their adhesive or grouting breaking down;
- weathering of roof tiles or roof ridge capping;
- gradual weathering and breakdown of bricks, mortar or concrete.

Overdue monthly instalments

if you pay your premium by monthly instalments and payment is overdue we can do one or both of the following:

- refuse to pay a claim if payment is **14** days (or more) late;
- cancel your policy without notifying you if payment is **1** month (or more) late.

Claims

Making a claim

Contact us as soon as possible if you suffer loss or damage, or if there is an incident that could result in a claim.

What you must do

Step 1 Make sure everyone is safe. For emergencies, please call 000.

Step 2 Try to prevent further loss or damage.

If possible take reasonable steps to prevent further loss, damage or liability (e.g. if there is a hole in the roof, arrange for it to be covered to prevent further water damage from the rain).

Step 3 Immediately report any theft and malicious damage to the police.

Give them a list of all stolen or damaged items. Keep details of the date reported, name of the police officer, police station reported to and the report number.

Step 4 Contact us as soon as possible.

You can call us **24** hours a day. If you delay reporting your claim, we may not pay for any additional loss or damage caused by your delay.

Describe details of what has been affected by the event (e.g. a broken window, storm damage or a list of stolen items).

NOTE: If the damage to your property or contents was caused by another person, please provide us their name and address or, if applicable, their registration details.

How the Goods and Services Tax (GST) affects this insurance

You must tell us about the input tax credit (ITC) you are entitled to for your premium and your claim, each time you make a claim. If you do not give us this information or if you tell us an incorrect ITC, we will not pay any GST liability you incur. Our liability to you will be calculated taking into account any input tax credit to which you are entitled for any acquisition which is relevant to your claim, or to which you would have been entitled were you to have made a relevant acquisition.

Legal liability claims

You must tell us about any incident that has caused an injury to others or damage to other people's property.

You also must immediately tell us about any demands made on you to pay compensation to others and any court actions or offers of settlement and send these to us.

If you make a legal liability claim that is covered under this policy we can decide to defend you, settle any claim against you or represent you at an inquest, official enquiry or court proceedings.

If we decide to defend you, settle any claim against you or represent you, then you must give us all the help we need, including help after your claim is settled.

For more details on 'Legal liability' cover see pages 36 to 37.

To process the claim, you must

- allow us to inspect the damaged property and/or contents;
- allow us to arrange for experts to assess the damaged property and/or contents and to quote on repair or replacement;
- provide us with a quote for repair or replacement if we ask for this. If you choose to use our recommended repairers (when available), there is no need to obtain your own quotes;
- when requested, provide us with all proofs of ownership and value, information, co-operation and assistance in relation to a claim (including giving evidence in court) as we may reasonably require;
- allow us, or a person nominated by us, to recover, salvage or take possession of your property and/or contents. When we ask, you must send any items to us, or cooperate in our collection or retrieval of such items;
- consult an expert if we ask for this.

What you must not do

- do not dispose of damaged parts or items of your property or contents without our consent;
- do not carry out or authorise repairs without our consent **unless** you cannot contact us and need to make emergency repairs to protect your property or contents;
- do not wash or clean or remove debris from any area damaged by fire without our consent **unless** you need to do this to prevent further loss;
- do not admit liability or responsibility to anyone else **unless** we agree;
- do not negotiate, pay or settle a claim with anyone else **unless** we agree;
- do not accept payment from someone who admits fault for loss or damage to your property or contents. Refer them to us instead.

If you do not comply

If you do not comply with 'What you must do' and 'What you must not do' we can reduce or refuse your claim and/or recover costs from you or cancel your policy.

If we decline a claim

We will provide reasons for our decision to decline and if you decide to lodge a claim, we will send you written confirmation of our decision.

How to establish your loss

Establish an incident took place

When making a claim you must be able to prove that an incident covered by your policy actually took place. If you do not do this, we will not be able to pay your claim.

We may obtain the following from the police:

- confirmation that you reported the incident;
- details of any investigations they undertook.

You must give us authority to access these records, if we ask.

Describe your loss or damage

You must also give us accurate and full details of what was lost, stolen or damaged and give us proof of value and ownership for items claimed if we request it.

When your property or contents are damaged

Allowing us, a repairer or an expert appointed by us, to look at what is damaged is usually all that is needed to prove your loss. Sometimes though we might ask you to produce a copy of the most recent plans and drawings for your property, photographs of your property or other evidence that supports the extent of the loss you have suffered. For valuable and badly damaged items, we may ask you to provide proof of ownership and value.

If we decide that you are unable to reasonably substantiate your claim, we might reduce or refuse your claim.

How to prove ownership and value

For lost, damaged or stolen items that are no longer available for inspection, you must validate your claim by giving us details of when and where they were purchased and reasonable proof of ownership and value.

We will decide what is reasonable proof of ownership and value depending on what you are claiming for, how old they are and their value. A statutory declaration is not of itself considered acceptable evidence of proof of ownership and value.

If you are unable to reasonably substantiate your claim, we can reduce or refuse your claim.

Your excess

What is an excess?

An excess is the amount you have to pay for each incident when you make a claim. Sometimes you might have to pay more than one type of excess. The amount and types of excess are shown on your certificate of insurance or in this PDS.

The types of excesses are:

| | |
|--|---|
| Standard excess | This excess applies to all property and contents claims. You can choose your standard excess from the range we offer. |
| Theft by tenants or their guests excess | For any claim under the insured event 'Theft or burglary by tenants or their guests' (see page 19), an excess of \$500 will apply in addition to any other excesses that apply. |
| Malicious acts or vandalism by tenants or their guests excess | For any claim under the insured event 'Malicious acts or vandalism by tenants or their guests' (see page 23), an excess of \$500 will apply in addition to any other excesses that apply. |
| Loss of rent – tenant default excess | For some claims under additional cover 'Loss of rent – tenant default' (see page 29), an excess of \$500 will apply in addition to any other excesses that apply. |
| Earthquake and tsunami excess | This excess applies in addition to any other excess if you make a claim for loss or damage as a result of an earthquake or tsunami. |
| Additional excess | In some circumstances, an additional excess may apply based on our assessment of the risk. This excess is payable in addition to any other excess unless stated otherwise in this PDS or your certificate of insurance. |
| Unoccupied excess | This excess applies in addition to any other excess, unless stated otherwise in the PDS, if you claim for loss or damage to your property or contents, occurring when the insured address has been unoccupied for more than 60 continuous days. |

When you claim for both property and contents

When both your property and contents at the one insured address are insured with us under this policy and your claim is for loss or damage to both arising from the one incident, you must pay whichever is the higher of your standard excesses (plus any other applicable excesses).

When we may waive your excess

When you make a claim for damage to your property or contents and the incident covered by your policy was caused by another person (not the tenant, or their guest) and we agree, we may waive the excess that would normally apply if you give us the name and address of the person responsible for the damage or if applicable their registration details.

How to pay your excess

When you make a claim we will choose whether to deduct the applicable excesses from the amount we pay you or direct you to pay the excesses to us or to the appointed repairer or supplier. We may require you to pay the excesses in full before we pay your claim or provide any benefits under your policy.

Refer to the PED Guide for further information

How we settle your claim

We choose how we settle property claims

If we agree to pay a claim for loss, theft or damage to your property, we will decide if we will:

- repair damage to your property;
- rebuild your property;
- pay you what it would cost us to repair or rebuild your property;
- pay you the sum insured for your property.

If we rebuild (or pay you what it would cost us to rebuild), we will do so on a 'new for old' basis.

If we repair (or pay you what it would cost us to repair), we will at our option repair on a 'new for old' basis or repair to a similar condition to what your property was in before the loss or damage occurred.

We may offer you a voucher, store credit or stored value card for the amount it would cost us to repair or rebuild an item.

We choose how we settle contents claims

If we agree to pay a claim for loss, theft or damage to your contents, we will decide if we will:

- repair damage to the contents;
- replace your contents 'new for old';
- pay you what it would cost us to repair or replace your contents;
- pay you the sum insured for your contents.

If we replace (or pay you what it would cost us to replace), we will do so on a 'new for old' basis.

If we repair (or pay you what it would cost us to repair), we will at our option repair on a 'new for old' basis or repair to a similar condition to what your contents were in before the loss or damage occurred.

We may offer you a voucher, store credit or stored value card for the amount it would cost us to repair or replace your contents.

We will not:

- pay more than the relevant sum insured or policy limit;
- pay extra to replace your property or contents to a better standard, specification or quality than they were before the loss or damage occurred **except** as stated in meaning of 'new for old';
- fix a fault that existed before the loss or damage occurred.

'New for old' means:

- we rebuild, replace or repair with new items or new materials that are available at the time of replacement or repair from Australian suppliers.
- we rebuild, replace or repair new for old regardless of age, with no allowance for depreciation.

For example, a leather lounge which was purchased **5** years ago for **\$5,000** and now worth **\$2,000**, will be replaced with a brand new leather lounge equivalent to your old lounge when it was new. Cover is not limited to **\$2,000**.

- we replace or repair to the same type, standard and specification (but not brand) as when new. If the same is not available, it means of a similar type, standard and specification (but not brand) when new. We can replace with a different brand.

'New for old' does not:

- include paying the extra cost of replacing or purchasing an extended warranty on any item;
- mean of a better standard, specification or quality than when new.

When items may be replaced to a better standard

Refrigerators, freezers, dishwashers, air conditioners, washing machines and dryers with less than a 3 star energy rating

For these items when being replaced, 'new for old' means replacing with a new item of equal specification (but not brand) and if you agree, it means replacing with a minimum 3 star energy rating if this is available. It can be a different brand.

Obsolete electrical appliances

For obsolete electrical appliances such as outdated dishwashers or air conditioners 'new for old' means, replacing or repairing to an equal specification (but not brand). If this is not available, it means to the nearest better specification available. It can be a different brand. We do not insure electrical or electronic items that are no longer able to be used for the purpose they were intended.

When items cannot be replaced 'new for old'

For these items (such as paintings, pictures and works of art), 'new for old' means that if the item cannot be replaced 'new for old' or repaired, we will pay you what it would have cost to buy the item immediately before the loss or damage occurred, up to the relevant limit.

Property claims

This section relates specifically to a claim made on your property policy and is in addition to the information in 'How we settle your claim' on pages 47 to 48.

When we authorise the repair or rebuilding of your property

If we need to source material in order to repair or rebuild your property, we will do our best to obtain new materials that are the same type, standard and specification. If the same is not available, we will use new materials of a similar type, standard and specification that are commercially available and compliant with current building regulations.

We may enter into any building contract with the selected repairer and/or supplier on your behalf. We will oversee the repairs and keep you informed of their progress.

If you decide not to repair or replace your property, or do not commence repair or replacement within 6 months of the date the loss or damage occurred, we will only compensate you for what it would have cost to repair or replace your property at the date of the loss or damage.

When we cannot match materials

**If we cannot find new materials to match undamaged parts,
we will use the closest match available to us.**

**If you are not satisfied with the materials we find
as the closest match before we repair your property:**

If we agree, you can pay the extra cost of replacing undamaged parts of your property to achieve a uniform appearance.

Or we will pay you what it would have cost us to repair or rebuild the damaged part.

Repairing or rebuilding damaged parts

We will only repair or rebuild the parts that are damaged in the incident covered by your policy. You cannot claim to replace undamaged parts of your property to create a uniform appearance, such as when:

- **one garage door is damaged**
we will only replace or repair the damaged one, not other doors.
- **roof tiles are damaged**
we will only replace the damaged ones, not the undamaged tiles, even if the undamaged tiles are faded and do not match the new ones used for repairs.
- **roof sheeting is damaged**
we will only replace the damaged roof sheeting, not the undamaged roof sheeting, even if the closest match available to us is a different shade or colour to the undamaged roof sheeting.
- **an external wall is damaged**
we will replace the damaged parts of the wall, not undamaged areas of the wall or other sides of your property.

For the limited circumstances where we will repair or rebuild undamaged parts read the section below.

When we will repair or rebuild undamaged parts

If we cannot match the new materials with the undamaged parts, we will only pay extra to create a uniform appearance when:

- **wall tiles are damaged**
we will replace undamaged wall tiles in the same room, stairs, hallway or passageway* so they match or complement new tiles used for repairs.
- **other wall coverings are damaged**
(e.g. paint, wallpaper, wood panels, but not tiles)
we will pay extra to paint, wallpaper or replace undamaged wall coverings in the same room, stairs, hallway or passageway* where the damage occurred.
- **floor coverings are damaged (including tiles)**
we will pay extra to replace continuously joined undamaged floor coverings of the same material in the same room, stairs, hallway or passageway* where the damage occurred.
- **kitchen cabinets, cupboards or benchtops are damaged**
see 'Repairing or replacing kitchen cabinets, cupboards or benchtops' below.

*For the meaning of these terms refer to the diagrams on pages 50 to 51.

Repairing or replacing kitchen cabinets, cupboards or benchtops

We will repair damaged parts of your kitchen

We will repair the damaged parts of your kitchen cupboards, cabinets or benchtops.

When we will replace undamaged parts of the kitchen

To create a uniform appearance, we will pay extra to replace undamaged parts of the same cupboard, cabinet or benchtop so that they match the repaired parts.

Same cabinet, cupboard or benchtop means:

- those parts continuously joined to the damaged parts (this is one 'section');
- made out of the same materials; **and**
- on the same level.

See the case study below for a visual explanation.

Note: Sometimes replacing the benchtop, door fronts or drawers in the undamaged area is all that is necessary to create a uniform appearance. We will decide what is necessary depending on the circumstances.

Case study

The extent of repairs carried out to match undamaged areas in a kitchen.

To match undamaged areas to the damaged parts, they must be:

- continuously joined; **and**
- on the same level; **and**
- made of the same material.

In this kitchen case study

Areas 1, 2 and 3 will be treated as separate sections. The oven breaks up the bottom level into two sections (e.g. if only section 2 is damaged, we will not pay to replace sections 1 and 3).

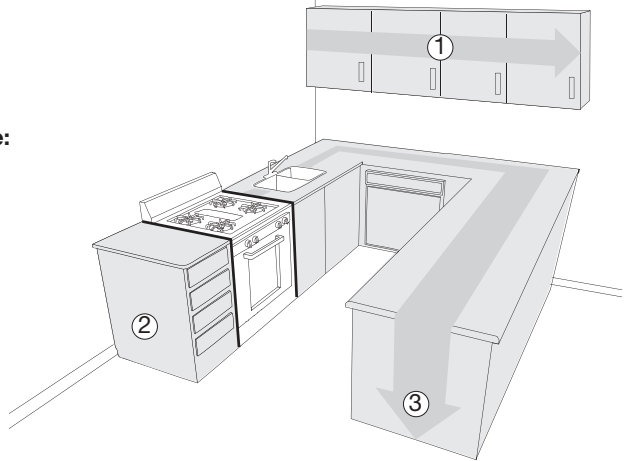

What we mean by same room, stairs, hallway or passageway

Same room

A room is an area starting and finishing at:

- its nearest walls
- nearest doorway, archway or similar opening of any width;
- a change in the floor or wall covering.

A hallway next to a room is not the same room, even if it has the same floor or wall covering as the room.

Any archway or similar opening separates a room **unless** it is a combined lounge-dining room (below).

Combined lounge-dining room

We will only combine rooms with a shared doorway, archway or similar opening when:

- they are lounge and dining rooms: **and**
- the shared doorway, archway or similar opening is wider than **82cm**; **and**
- the floor or wall covering is the same in both rooms.

Open plan areas

When there is no wall, archway, doorway or similar opening, the room continues until:

- a change in the floor or wall covering;
- the nearest wall, doorway, archway or similar opening.

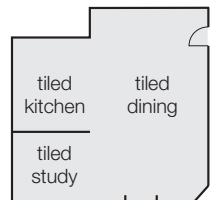
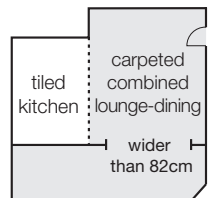
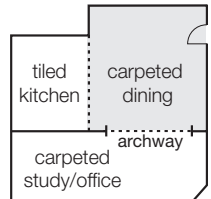

Same passageway or hallway

A passageway or hallway has the same meaning as a room. We will not combine a hallway and a room.

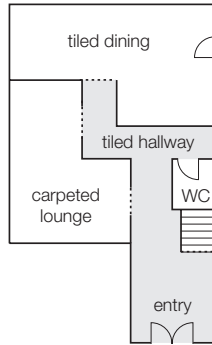

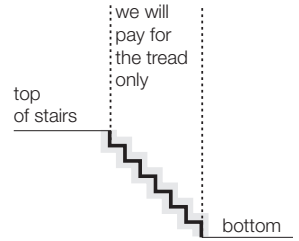

Same stairs

Side view of stairs



Legend

-  Shaded areas show the area that we consider the same room, stairs, hallway or passageway.
-  Solid lines represent floor to ceiling walls.
-  Dotted lines show boundaries of a room or area where there is no physical barrier present (e.g. no wall or door).

Dealing with defects

If a known defect is the cause of the damage

We do not pay for loss or damage caused by a defect, structural fault or design fault at your property that you knew about (or should reasonably have known about) and did not fix before the loss or damage occurred.

If an unknown defect is the cause of the damage

If an incident covered by your policy damages your property and an unknown defect was the cause or part of the cause, we will pay for the resulting damage. If the unknown defective part of your property is also damaged by the same incident, we will fix this as well.

We do not rectify structural or design faults

When we accept a claim, we will not pay extra to rectify a structural or design fault at your property that you knew about (or should reasonably have known about). We will only pay you what it would have cost us to fix the damage from the incident covered by your policy, or if we agree, you can pay us the extra amount it costs to rectify the structural or design fault at your property.

If undamaged defective parts of your property will not support repairs

If undamaged defective parts of your property you knew about (or should have reasonably have known about) will not support repairing the damage caused by an incident covered by your policy, we will only pay what it would have cost us to repair the damage had your property not been defective.

For known defects or faults

Once you become aware of a defect, structural or design fault at your property, you must rectify it as soon as possible because there is no cover for loss or damage due to that defect. If you do not rectify the defect or fault, you may not be covered or we might not offer a renewal of your policy.

Changes to your property

If you want to change the design of your property

When rebuilding your property, if we agree, you can choose to change the design of your property or upgrade parts of it, providing you pay the extra costs of doing this. If you want to downsize your property for less cost than you are entitled to claim, we will not pay more than it costs us to rebuild the downsized property.

Choosing to rebuild on another site

If your property is to be rebuilt after an incident covered by your policy, you can choose to have your property rebuilt on another site providing you pay any extra costs involved.

Lifetime guarantee on property repairs

When we repair or rebuild your property, we guarantee the quality of materials and workmanship of that work for the lifetime of your property if we:

- authorise;
- arrange; **and**
- pay the builder or repairer directly for this work.

What we guarantee

We guarantee the material used and standard of the workmanship to be free of defects. If a defect arises in the lifetime of your property as a result of poor quality workmanship or use of incorrect materials, then we will rectify the problem.

This guarantee does not apply:

- to repairs you authorise or make yourself;
- to loss, damage or failure of any electrical or mechanical appliances or machines;
- to wear and tear consistent with normal gradual deterioration of your property (e.g. paint peeling off after its expected life cycle, wood rotting from moisture in the air or ground, roofs weathering or a hot water tank leaking after its guaranteed life);
- where we agree with a repair quote and we give you, or the builder or repairer, payment for the cost of the repairs and you arrange the repairs.

Contents claims

This section relates specifically to a claim made on your contents policy and is in addition to the information in 'How we settle your claim' on pages 47 to 48.

When we repair or replace your contents

If we choose to repair damage to the contents or replace the contents, we will repair or replace with items or materials that are reasonably available at the time of repair or replacement from Australian suppliers.

We will do our best to replace to the same type, standard and specification (but not brand) as when new. If the same is not available, we will replace with items or materials of a similar type, standard and specification when new. It can be a different brand.

When we cannot match materials

If we cannot find a contents item match we will use the closest match reasonably available to us.

If you are not satisfied with what we choose before we repair the contents:

If we agree, you can pay the extra cost of replacing undamaged parts of your contents to achieve a uniform appearance.

Or we will pay you what it would have cost us, but only if we agree to this.

Items that form part of a set or collection

We will only repair or replace contents that are lost or damaged by an incident covered by your policy. You cannot claim to replace undamaged parts of the contents (e.g. when a lounge chair which is part of a suite is damaged beyond repair. We will pay to replace that chair, not the whole lounge suite).

When we will repair or replace undamaged contents

We will only repair or replace contents that are lost or damaged by an incident covered by your policy. You cannot claim to replace undamaged contents or undamaged parts of contents.

But there are limited circumstances where we will repair undamaged parts of contents to create a uniform appearance, when:

– internal blinds and curtains

if we can't match the new material or parts with the undamaged ones, if necessary, we will pay extra to replace undamaged blinds and curtains in the same room, stairs, hallway or passageway* where the damage occurred.

– carpets or other floor coverings

if we can't match the new material or parts with the undamaged ones, if necessary, we will pay extra to replace undamaged floor carpets and other coverings in the same room, stairs, hallway or passageway* where the damage occurred.

*See pages 50 to 51 for 'What we mean by same room, stairs, hallway or passageway'.

If you want to change the contents

When repairing or replacing the contents, if we agree, you can choose to change the make and model of the contents item or upgrade to a different make and model of it, providing you pay the extra costs of doing this. If you want to downsize the contents item for less cost than you are entitled to claim, we will not pay more than it costs us to repair or replace the downsized contents item.

Other claims information

Potential impact on cover and premiums

After a property claim

If we only pay part of the sum insured to you, your property policy continues for the period of insurance.

If we pay the full sum insured to you, all cover under your property policy stops. There is no refund of premium. If you have been paying premiums by instalments, we will deduct the remaining instalment premiums for the unexpired period of insurance from the amount we pay for the claim.

After a contents claim

If we pay part of, or the full contents sum insured, the contents sum insured is automatically reinstated and cover continues for the period of insurance. You may need to change your insured address. You should reassess your contents sum insured. There is no refund of premium if you reduce your sum insured by the amount of your claim.

Salvaged property and contents items

If we replace or compensate you for an item, we then own the damaged or recovered item. If we agree you can keep an item we will determine the salvage value and we can deduct this amount from any payment we make to you.

Our right to recover claims we pay from those responsible

After we pay a claim under this policy, we can decide to take legal action in your name to recover money from the person or entity that caused loss, damage or liability. You must give us all the help we need to do this. If we recover money that belongs to you and was not part of the claim we paid, we will give this to you.

[Refer to the PED Guide for further information](#)

Other Important Information

What happens with cancellations

Cancellation by you

You may cancel this policy at any time. If you cancel this policy outside the cooling off period, you will be refunded the unexpired portion of the premium, less the cancellation fee and less any non-refundable government charges if the refund is more than **\$5**. See below for the cancellation fee.

Cancellation by us

We can cancel your cover where the law allows us to do so. If we cancel this policy outside the cooling off period, you will be refunded the unexpired portion of the premium, less the cancellation fee and less any non-refundable government charges if the refund is more than **\$5**. If we cancel your policy due to fraud, we will not refund any money to you.

Cancellation fee

| Fee | Details |
|--|---|
| <p>Cancellation fee</p> <p>We incur costs in establishing and administering your policy. If you cancel your policy we will charge a cancellation fee on each insured address.</p> <p>A cancellation fee will not apply in some circumstances, including:</p> <ul style="list-style-type: none">– when you are transferring your policy to another property;– if you cancel the policy within the cooling off period and have not made a claim. | <p>The amount of the cancellation fee is \$30 (plus (if applicable) FSL plus GST plus stamp duty) for all property and contents cover for one insured address.</p> <p>This fee is deducted from any refund we give you. If the refund is less than the fee, a refund will not be issued and we will not charge you an additional amount to cover the difference.</p> |

Words with special meanings

Accidental loss or damage

means loss or damage that occurs without intent.

Actions or movements of the sea

means:

- rises in the level of the ocean or sea;
- sea waves;
- high tides or king tides;
- any other actions or movements of the sea.

Actions or movements of the sea **do not** include a tsunami or storm surge.

Agent

means someone who acts on your behalf to arrange and manage the rental of your property, including the collection of rent.

Business activity

means:

- any activity specifically undertaken for the purposes of earning an income; **or**
- any activity registered as a business and which you are obliged by law to register for GST purposes.

It does not mean the tenancy of your property or unit.

Certificate of insurance

means the latest certificate of insurance, including the insurance account, we have given you. It is an important document as it shows the covers you have chosen and other policy details.

Common property

means land or areas at the insured address that both you and other people are entitled to use (e.g. common property in a multi-dwelling development).

Computer

means an electronic digital device that stores, retrieves and processes data and can be programmed with instructions. It includes devices such as a PC, laptop, electronic notebook and PDA. A computer is composed of hardware and software, including:

- CPU;
- monitor;
- processor;
- hard drive;
- keyboard and mouse.

Contents

see page 14.

Contents with fixed limits

see the table on page 16.

Environmental improvements

means an alteration or addition to your property which is intended to contribute to the protection or conservation of the environment. These may include items such as solar panels, rainwater tanks or compost equipment.

Flood

see page 17.

Good condition

means your property or unit and contents do not have any faults or defects that might cause loss or damage to your property and contents, loss or damage to property of others or injury to people. This includes **but is not limited** to the following:

- the roof does not leak when it rains;
- there are no areas of the roof that are rusted through;
- there is no wood rot, termite or white ant damage to your property or unit;
- there are no holes in floors, walls, ceilings or any other parts of your property or unit (e.g. external wall cladding, internal plaster, floorboards);
- there are no boarded up or broken windows;
- there are no steps, gutters, flooring, walls, ceilings or any other areas of your property or unit that are loose, falling down, missing or rusted through;
- all previous damage including damage caused by flood has been repaired;
- your property or unit is not infested with vermin;
- there are no squatters or unauthorised persons occupying your property or unit.

Guest

means any person invited onto the insured address by the tenant for social or entertainment purposes.

Incident

means a single event, accident or occurrence which you did not intend or expect to happen.

Insured address

see page 12.

Insured events

means:

- the insured events on pages 17 to 24; and
- if you have optional 'Accidental damage at the property' cover it also means accidental loss or damage that is not excluded by the policy.

Loss or damage

means physical loss or physical damage.

PED Guide

see page 3.

Period of insurance

means when your policy starts to when it ends. It is shown on your certificate of insurance.

Periodic rental agreement

means the agreement that applies when a tenant continues to occupy the insured address after a written rental agreement for the insured address has expired, and a notice to leave, notice of intention to leave or abandonment notice has not been given by the tenant to you or your agent, or by you or your agent to the tenant.

Policy

means your insurance contract. It consists of this PDS and any SPDS we have given you, your latest certificate of insurance.

Property

see page 12.

Rental agreement

means a written rental agreement or a periodic rental agreement.

Retaining wall

means a wall, which is not part of your residential property, that holds back or prevents the movement of earth.

Storm

means a storm, cyclone or severe atmospheric disturbance. It can be accompanied by strong winds, rain, lightning, hail, snow or dust.

Storm surge

means a rush of water onshore associated with a low pressure system and caused by strong winds pushing on the ocean's surface.

Strata title

means any form of land title which allows for multiple titles to exist in or on a block of land where the common property is held under a single separate title.

Sum insured

see page 8.

Tenant

means the person or persons who have been granted the right to occupy the insured address under the rental agreement and includes any other person who usually resides at the insured address.

Unit

means the unit, villa, townhouse or apartment in a strata title development. It does not include common property.

Unoccupied and occupied

unoccupied means:

- the property or unit is not furnished enough to be lived in; **or**
- no-one is eating, sleeping and living at the property or unit; **or**
- the property or unit is not connected to utilities;

occupied means:

- the property or unit is furnished enough to be lived in; **and**
- someone is eating, sleeping and living at the property or unit; **and**
- the property or unit is connected to utilities.

'furnished enough to be lived in' means the property or unit contains at least:

- a bed; **and**
- a clothes and linen storage area; **and**
- an eating table or bench; **and**
- a refrigerator and a cooking appliance.

Weekly rental amount

means the lesser of the:

- amount shown on your certificate of insurance; **or**
- weekly rent payable under your rental agreement; **or**
- amount a tenant would have paid immediately before the insured incident, assessed by a suitably qualified person agreed to by us, if the insured address was not tenanted at the time loss or damage occurred;

less agent's commission and fees.

We, our, us and Suncorp

means Suncorp Metway Insurance Limited.

Written rental agreement

means a current and valid written agreement for the insured address between you (or your agent) and your tenant that:

- complies with the requirements specified in the relevant residential tenancy legislation (or its equivalent); **and**
- includes the following minimum requirements – a start and finish date, a minimum duration, the amount of rent payable, the bond that the tenant is required to pay and the notice to leave requirements.

You/your

see page 12.

How we will deal with a complaint

If you have a complaint about our products or services (even if through one of our service providers) or our complaints handling process, please let us know so that we can help.

You can contact us:

| | |
|-------------------|--|
| By phone | 13 11 55 |
| In writing | Suncorp Insurance PO Box 1453 Brisbane Qld 4001 |
| In person | By visiting one of our local branches |
| By email | customer.relations@suncorp.com.au |

Please include the full details of your complaint and explain what you would like us to do.

When we receive your complaint, we will consider all of the facts and attempt to resolve your complaint by the end of the next business day.

If we are not able to resolve the matter to your satisfaction, it will be referred to the relevant team leader or manager, who will review your complaint and contact you within **5** business days of us receiving your complaint.

If you remain dissatisfied the matter will be referred to our Internal Disputes Resolution team (IDR). Our IDR team will review your complaint, and provide you with their final decision within **15** business days of your complaint being referred to them.

The contact details for our IDR team are: By phone: 1300 264 053; By fax: 1300 316 047; In writing: Internal Dispute Resolution, Suncorp Metway Insurance Limited, PO Box 14180, Melbourne City Mail Centre, VIC, 8001; By email: idr@suncorp.com.au.

If we require additional information for our assessment or investigation of your complaint, we will agree with you a reasonable alternative timeframe to resolve your complaint.

If we are unable to resolve your complaint within **45** days, you may take your complaint to the Financial Ombudsman Service (the FOS), even if we are still considering it. The contact details for the FOS are set out below.

What if you are not satisfied with our final IDR decision?

We expect our procedures will deal fairly and promptly with your complaint. However, if you remain dissatisfied, you may be able to access the services of the FOS. The FOS is an independent external dispute scheme and their service is free to you. Any decision the FOS makes is binding on us, provided you also accept the decision. You do not have to accept their decision and you have the option of seeking remedies elsewhere.

The FOS is available to customers who fall within their terms of reference. The FOS will advise if they can help you.

You can contact FOS:

| | |
|---------------------|---|
| By phone: | 1300 780 808 |
| By Fax: | (03) 9613 6399 |
| By email: | info@fos.org.au |
| In writing: | Financial Ombudsman Service GPO Box 3 Melbourne VIC 3001 |
| By visiting: | www.fos.org.au |

General Insurance Code of Practice

We support and adhere to the General Insurance Code of Practice. You can get a copy of the code from the Insurance Council of Australia website (insurancecouncil.com.au) or by phoning **(02) 9253 5100**.

Report insurance fraud

Insurance fraud is not a victimless crime. It imposes additional costs on honest policy holders and wastes the valuable resources of our community. This means it affects everyone.

We actively pursue fraudulent and inflated claims in order to keep your premiums as low as possible. Fraudulent claims will be investigated and may be reported to the police.

Help us fight insurance fraud by reporting:

- inflated vehicle or home repair bills;
- staged vehicle or home incidents;
- false or inflated home or vehicle claims;
- home or vehicle fires which may be intentionally started, including by someone known to you.

To report suspected insurance fraud call: **1300 881 725**. Let's work together to reduce the impact of insurance fraud on the community.

Financial Claims Scheme

This policy may be a 'protected policy' under the Federal Government's Financial Claims Scheme (FCS) which is administered by the Australian Prudential Regulation Authority (APRA).

The FCS only applies in the extremely unlikely event of an insurer becoming insolvent and the Federal Treasurer making a declaration that the FCS will apply to that insurer.

The FCS entitles certain persons, who have valid claims connected with certain protected policies issued by that insurer to be paid certain amounts by APRA.

Information about the FCS can be obtained from APRA at apra.gov.au or by calling **1300 55 88 49**.

PDS prepared 19 October 2012

This insurance is issued by
Suncorp Metway Insurance Ltd
ABN 83 075 695 966 AFSL No. 229869

The insurer is a related body corporate of
Suncorp-Metway Ltd ABN 66 010 831 722
AFSL No. 229882 (Suncorp Bank).

Various products and services are provided by different entities in the Suncorp Group. The different entities in the Suncorp Group are not responsible for, do not guarantee and are not liable in respect of products or services provided by other entities in the Suncorp Group. Suncorp Bank does not guarantee and is not liable for this product.

This product is not a bank deposit or other bank liability.

How to contact us



Call
13 11 55



Claims
13 25 24



*Insurance
Fraud Hotline*
1300 881 725



Online
suncorp.com.au



*Local
branch*